

UNISON CONTROLS PVT. LTD.

SOLID STATE RELAY

ISO 9001:2015 & ISO 14001:2015 CERTIFIED by InterConformity GmbH

Approved By
 CE EN-60947-5-1
 CUL US E481640

MODEL 901

ZERO CROSS DETECTION OUTPUT AC CONTROL 3Q TRIAC & BACK TO BACK SCR



FLAP COVER



5mm AL PLATE
 Only Al plate take 14 Amp Load Current at 40°C.



C56 HEAT SINK
 Only C56 Heat Sink take 20 Amp Load Current at 40°C.



2mm CU PLATE

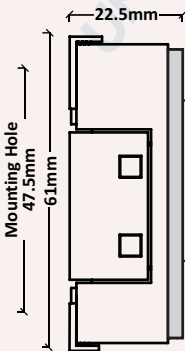
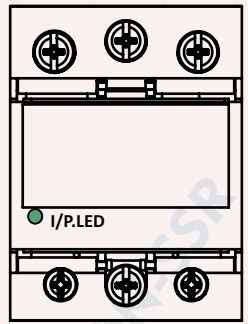

Slim 22.5mm with 5mm Aluminium Plate

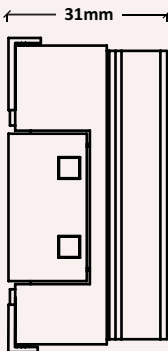

Slim SSR with C-56 Inbuilt Heat Sink

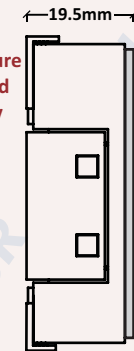

Slim 19.5mm with 2mm Copper plate Plate

- Product Temperature withstand 150°C.
- "19.5 & 22.5 MM SLIM Height" SSR Design.
- "31 MM Height" Inbuilt "C-56" Heat sink SSR Design.
- With easy open & lock IP 20 protection Flaps on I/P & O/P Terminals.
- Zero Voltage Turn-On SSR.
- Rating from 16 Amp to 200 Amp @25°C 24-600 VAC.
- Short Circuit Protected SSR up to 115 Amp per phase current by help of suitable "B" curve MCB.
- No need to use semiconductor Fuse due to short circuit protected SSR.
- Fire Retardant Plastic as per UL94 VO GRADE.
- New improved SEMS Screw - Washers input & Output terminals.
- Improved Direct Bonded Copper (DBC) for higher Amp Relays.
- High resistance to aggressive chemicals and dust due to special Potting.
- Logic compatibility, Fast switching, Low coupling capacitance.
- Inbuilt transient voltage suppressor.

ORDERING FORMAT

UNI	901	X	X	X	XX	XXX	XX	XXX
UNI	901	Z	D	A	60	50	01	AL5
		D : DC Input	Output Voltage		Control Input			
			48: 24-480 VAC 60: 24-600 VAC		01 : 4-32 VDC with snubber			
		Z : Zero Cross Over	A : AC Output		Output Current Rating		Plate Specifications	
					16,25,40 50,75,90,150,200		AL5: 5mm AL Plate CU2: 2mm Cu Plate C56: C-56 Aluminium Heat Sink	
EXAMPLES								
UNI 901 ZDA 48 25 01 AL5								
UNI 901 ZDA 60 150 01 CU2								
NOTE 1 : 48: 24-480 VAC available for 16Amp to 40Amp. 60: 24-600 VAC available for 50Amp to 200Amp.				NOTE 2 : AL5 Plate available for 16Amp to 50Amp CU2 Plate available for 75Amp to 200Amp C56 Heat sink available for 16Amp to 50Amp				

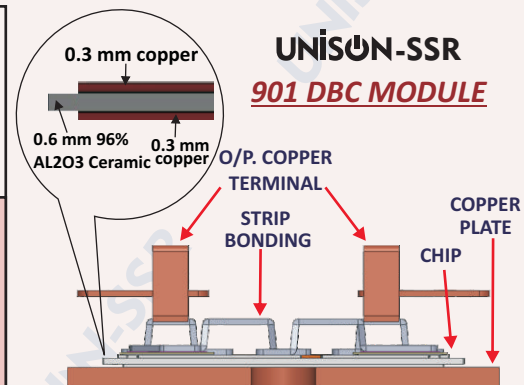

UNISON MODULES USE NEW IMPROVED LEAD FREE SOLDER PASTE RATHER THAN SOLDER PREFORMS.

Direct Copper Bonded (DCB) or Direct Bonded Copper (DBC) improves the conduction of heat from semiconductor chip to external heat sink as well as reduces mechanical stress in connection to major load changes. Here two layers of 0.3 mm copper is bonded to ceramic at temperature above 1020 °C. Coefficient of thermal expansion of copper is higher than ceramic (96% AL203) so a joint layer is generated between them at high temperature which will not cause thermal stress or fatigue on power output semiconductors.

ADVANTAGES OF SSR OVER CONTACTOR / MECHANICAL

- ❖ Zero voltage turn-on
- ❖ High resistance to shock, vibration and abrasion
- ❖ High resistance to aggressive chemicals and dust
- ❖ No electromechanical or acoustical noise
- ❖ Logic compatibility
- ❖ Low coupling capacitance
- ❖ Long life cycle . Up to 10¹¹ cycles
- ❖ Increased system temperature accuracy
- ❖ Improved system reliability because SSRs have no moving parts or contacts to degrade
- ❖ No contact arcing, low electromagnetic interference, high surge capability
- ❖ Solid state Relays offer a very fast response time with absolutely NO contact bounce
- ❖ SSRs are typically smaller than EMRs, conserving valuable real estate in printed-circuit board applications
- ❖ SSRs can be provided as surface-mount technology (SMT)parts, which means lower cost and easier SMT printed-circuit board manufacture
- ❖ Do not generate electrical noise

Note : Specifications are subject to change without prior notice.

Web: www.unisoncontrols.com Email : info@unisoncontrols.com

Tel: +91-79-29759845, Mob: +91-62-62-700-700



UNISON CONTROLS PVT. LTD.

SOLID STATE RELAY

General Specification

Max Barrier Layer Temperature (T _{max})	< 125 °C
Ambient Temperature Range (T _{amb})	0-85 °C
SSR Storage Temperature Range (T _{st})	-40°C to 80°C
Input Terminal Screw Torque Range	τ = 1.6 N.m (Max.)
Output Terminal Screw Torque Range	τ = 2.5 N.m (Max.)
Power Factor COSφ @ Max. Load @ 480 VAC	> 0.55
Housing Material	UL-94 V0 Grade
Base Plate	5mm Aluminium, 2mm Copper, C-56 Heat Sink
SSR Weight	≤ 120 grams
Control Input Electrical Wire Size (Max.)	Up to 2.1 sq mm(14 AWG)
Power Output Electrical Wire Size (Max.)	Up to 33.6 sq mm(2 AWG)
Test Standards:	ROHS,IP20
Approval Done:	UL 508, CSA 22-2 IEC 60947-5-1:2016
Pending Approvals:	VDE, IEC 62314:2006

Input Technical Specifications

Parameters	Unit	ZDA Type Selection
Control Voltage Range	V	4-32 VDC
Input Frequency Range	Hz	-
Reverse Polarity Protection	-	YES
Control Supply Current Consumption	mA	4-16 mA
Input Impedance (Current Regulator Circuit Impedance)	Ω	1 kΩ - 2 kΩ
Minimum Turn ON Voltage	VDC	3.5 VDC
Turn OFF Voltage	VDC	< 3.25 VDC
Control Input Status Indication	-	GREEN LED Indication
Maximum Turn ON Time	mS	≤ 1/2 Cycle (10 mS)
Maximum Turn OFF Time	mS	≤ 1/2 Cycle (10 mS)

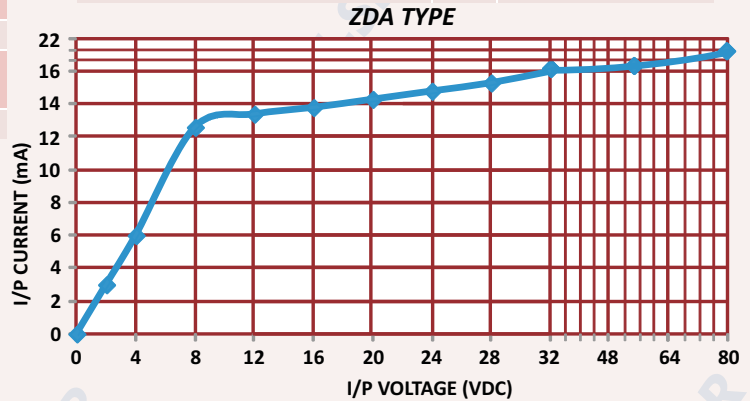

Output Technical Specifications @ 25°C Unless Specified

Parameters	Symbol	Unit	16 Amp	25 Amp	40 Amp	50 Amp	75 Amp	90 Amp	150 Amp	200 Amp
Operating Voltage Range	V _{AC}	V _{RMS}	24-480 VAC - 3Q TRIAC			24-600 VAC BACK TO BACK SCR				
Operating Frequency Range	f	Hz	47-63 Hz							
Peak Inverse Voltage	PIV	V _{PK}	800	800	800	1600	1600	1600	1600	1600
Max. Surge Voltage With Stand Capacity (<1 Second)	V _{surge}	V _{RMS}	2700 V_{RMS} (3800 V_{PK})							
Rated Operational Current AC51a @ 20°C (Resistive Load)	I _T	Amp	16	25	40	50	75	90	150	200
Maximum Load Short Circuit Protection Current @ 55°C	I _{SC}	Amp	-	-	-	15	50	63	80	115
"B" Curve D.P. MCB Rating for Short Circuit Protection	-	Amp	-	-	-	16	50	63	80	125
NON Repetitive Surge Peak ON-State Current @ Rated V _{RRM} applied for 1/2 Cycle t=10 mS / t=8.33 mS (50 Hz/60 Hz)	I _{TSM} @ 50 Hz	A _P	120	260	420	800	1100	1200	1750	2250
	I _{TSM} @ 60 Hz	A _P	126	273	441	840	1155	1260	1837	2360
Max. I²t for Fusing @ t=10 mS (50Hz)	I ² t	A ² s	72	340	880	3000	6000	7200	15000	25000
Max. I ² t for Fusing @ t=8.33 mS (60Hz)	I ² t	A ² s	65	305	795	2750	5470	6510	13850	22880
Max. Peak ON-state voltage Drop at Full Control	V _{TM}	V _{RMS}	≤ 1.2	≤ 1.2	≤ 1.2	≤ 1.2	≤ 1.2	≤ 1.2	≤ 1.2	≤ 1.2
Minimum Isolation Resistance between Input Terminals (+3,-4) to Output Terminals (~1,~2) @ 500 VDC	Ω	GΩ	50	50	50	50	50	50	50	50
Isolation Voltage Input Terminals (+3,-4) to Output Terminals (~1,~2) for 1 Minute (ZDA Type)	V _{ISO}	kV	6	6	6	8	8	8	8	8
Isolation Voltage Input & Output Terminal (+3,-4,~1,~2) to Body Isolation for 1 Minute	V _{ISO}	kV	6	6	6	6	6	6	6	6
Max. Rate of Rise OFF-State Voltage	dv/dt	V/μS	400	400	500	600	600	1000	1000	1000
Max. Rate of Rise OFF-State Current	di/dt	A/μS	50	22	50	100	125	150	300	300
Max. Peak Repetitive Forward OFF-State Voltage	V _{DRM}	V	800	800	800	1200	1200	1600	1600	1600
Max. Peak Repetitive Forward OFF-State current	I _{DRM}	mA	0.05	0.05	0.05	0.1	0.1	0.05	0.3	0.3
Max. Peak repetitive reverse off-state Voltage	V _{RIRM}	V	800	800	800	1200	1200	1600	1600	1600
Max. Peak repetitive reverse off-state current	I _{RIRM}	mA	0.05	0.05	0.05	0.1	0.1	0.05	0.3	0.3
Max. DC Gate Trigger Voltage	V _{GT}	V	1.2	1.2	1.5	1.5	1.3	1.5	1.3	1.3
Max. DC Gate Trigger Current	I _{GT}	mA	50	50	50	8.8	10	20	150	150
Turn OFF Time	t _q	μS	25	20	35	120	150	200	100	100
Maximum Latching Current	I _L	mA	80	100	100	160	180	200	400	500
Maximum Holding Current	I _H	mA	60	75	60	150	150	150	200	250
Thermal Resistance R _θ (Junction to case)	R _{θ(j-c)}	°C/W	0.8	0.6	0.52	0.35	0.22	0.2	0.09	0.07
OFF State SSR Leakage Current @ Rated Voltage & Frequency (Snubber Leakage)	I _{leak}	mA	For 230 VAC < 1 mA			For 230 VAC < 1.5 mA				
			For 440 VAC < 2 mA			For 440 VAC < 3 mA				
SCCR Current Rating (less than 100 μS)	I _{SCCR}	kA	-	-	-	10 kA	10 kA	10 kA	10 kA	10 kA
Weight	W	gm	≤ 110	≤ 110	≤ 110	≤ 110	≤ 120	≤ 120	≤ 120	≤ 120

Note : Specifications are subject to change without prior notice.

Web: www.unisoncontrols.com Email: info@unisoncontrols.com

Tel: +91-79-29759845, Mob: +91-62-62-700-700



UNISON CONTROLS PVT. LTD.

SOLID STATE RELAY

Zero Cross Switching SSR (ZDA)

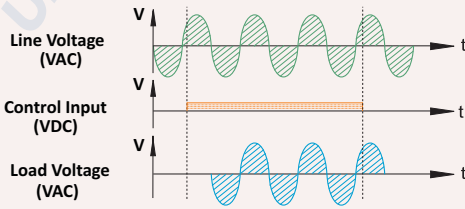

When control input is given to the SSR, irrespective of line voltage condition, output will be ON after zero crossing of sine wave. Zero cross switching SSRs are recommended when LOAD voltage gradually start to increase after zero crossing. It reduces chances of instant high voltage spike applied to the LOAD. Due to this characteristic, it reduces the surge current pass through LOAD during first conduction cycle. Load will be ON in less than 10mS duration for 50Hz line voltage & 8.33mS duration for 60Hz line voltage. These RELAYS are most suitable for industrial applications of heater loads, inductive loads, capacitor bank switching etc. When control input is removed, output of the SSR will be OFF after load current decreases to minimum holding current of the thyristor. This is due to the characteristic of thyristor. Above graph indicates functionality of zero switching SSR.

ZERO CROSSOVER Waveform

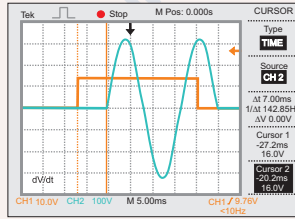

CONNECTION DIAGRAM

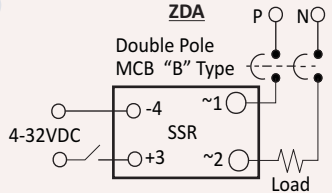

BLOCK DIAGRAM

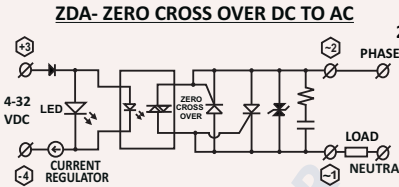

THERMAL DERATING CURVE WITH HEAT SINK

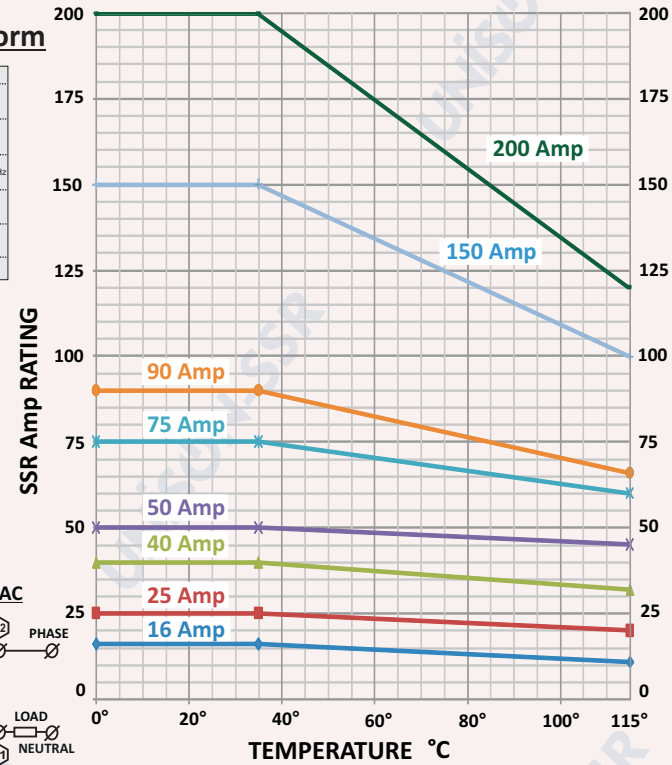

25AMP-MODEL 901 ZDA 48 25 01 C56

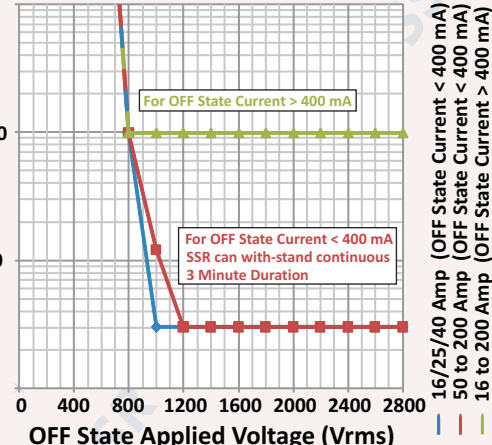
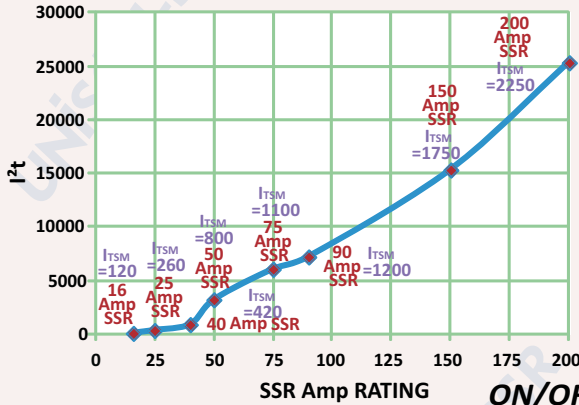

ON/OFF TYPE SSR Connection Diagram

Circuit diagram 901 model - ON/OFF type Star Connection without neutral

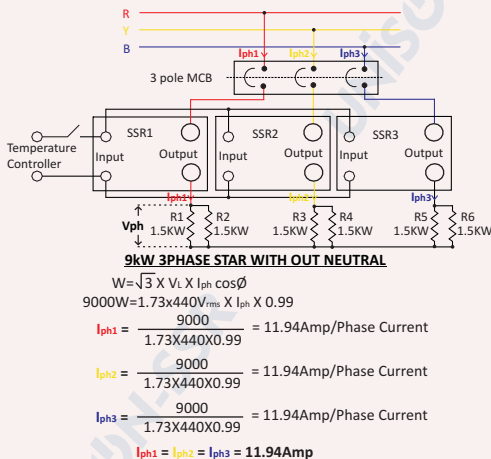

Circuit diagram 901 model - ON/OFF type Star Connection with neutral

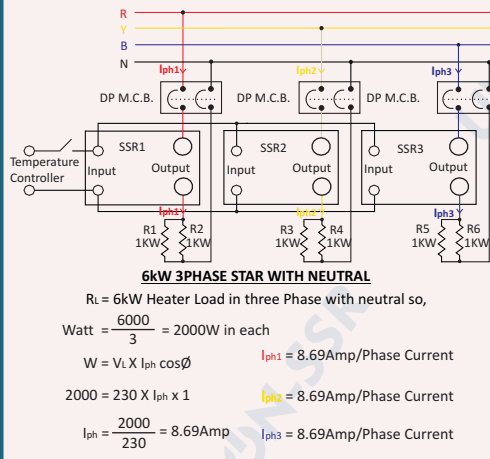

Circuit diagram 901 model - ON/OFF type Closed Delta Connection

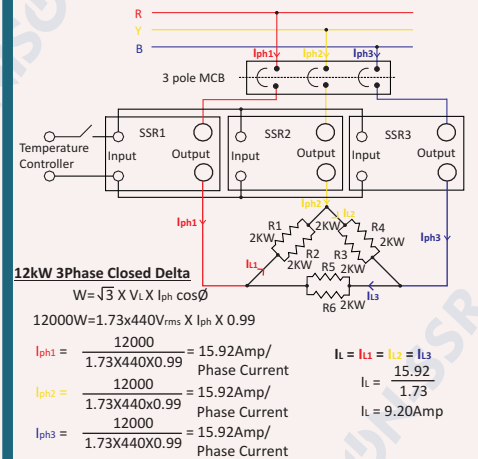

Note : Specifications are subject to change without prior notice.

Web: www.unisoncontrols.com Email: info@unisoncontrols.com

Tel: +91-79-29759845, Mob: +91-62-62-700-700



UNISON CONTROLS PVT. LTD.

SOLID STATE RELAY

AIRFLOW FOR EFFICIENT HEAT TRANSFER

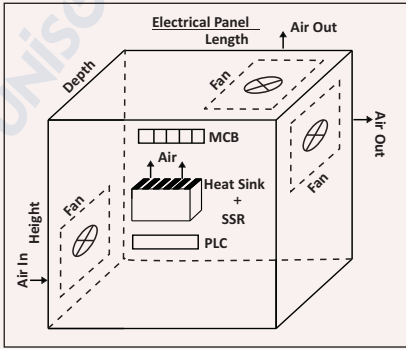

- ⇒ Heat Sink Fins should be in Vertical Position So that Hot Air flow from Bottom to Top - Self Cooling.
- ⇒ Our heat sinks are designed in such manner that horizontal & vertical convection both occurs properly.
- ⇒ Keep 20mm Gap at Top and Bottom of Heat Sink.
- ⇒ Apply Heat Sink Compound between SSR and Heat Sink.
- ⇒ The Screw should be tightened properly so that total Exposed Aluminum is Sufficient to Dissipated One Watt of Heat Generated.
- ⇒ **Advantages of using DBC Technology :**
Copper has higher thermal conductivity So more heat dissipation of junction to case & case to sink. Due to this thermal resistance $R_{\theta jc}$ is very less. Reduction in thermal resistance increases thermal efficiency of whole system.

THERMAL CALCULATION	
$\Delta T = T_j - T_a$	= $P(R_{\theta jc} + R_{\theta cs} + R_{\theta sa})$
T_j	= Junction Temperature (°C) 125 °C
T_a	= Ambient Temperature(°C)
P_d	= Power Dissipation (Watts) Voltage Drop X Load Current
$R_{\theta jc}$	= Thermal Resistance Junction to Case °C/W
$R_{\theta cs}$	= Thermal Resistance of Heat Sink Compound (0.2°C/W Type)
$R_{\theta sa}$	= Thermal Resistance of External Heat Sink (°C/W) it depend upon Length, Width, Expose Aluminum (0.5 to 5)

NOTE : If SSR Current Capacity is high and it is mounted on lower capacity heat sink than maximum load current will also decrease as heat dissipation area decreases.

Example: 1) 50Amp SSR used for 26Amp Load Current than "G-68" Type of Heat Sink. 2) 50Amp SSR used for 32Amp Load Current than "B-48" Type of Heat Sink.

HEAT SINK SELECTION GUIDE (Resistive LOAD)

901 MODEL / HEATSINK	HEATSINK RATING	16 AMP SSR	25 AMP SSR	40 AMP SSR	50 AMP SSR	75 AMP SSR	90 AMP SSR	150 AMP SSR	200 AMP SSR
AL5	12	8.5	10	12	12	-	-	-	-
C-56	16	10	12	14	16	-	-	-	-
G-68	26	-	16	18	26	-	-	-	-
B-48	36	-	-	-	32	36	36	-	-
B-72	60	-	-	-	-	55	60	-	-
A-100	80	-	-	-	-	-	65	75	80
A-190	Upto 115 A for 1 SSR	-	-	-	-	-	-	115*	115*
	Upto 132 A for 3 SSR	-	-	-	-	-	36 A x 3 = 108 A	40 A x 3 = 120 A	44 A x 3 = 132 A
A-190 WITH FAN	Upto 115 A for 1 SSR	-	-	-	-	-	-	115*	115*
	Upto 156 A for 3 SSR	-	-	-	-	-	40 A x 3 = 120 A	45 A x 3 = 135 A	52 A x 3 = 156 A
A-285	Upto 210 A for 3 SSR	-	-	-	-	-	-	65 A x 3 = 195 A	70 A x 3 = 210 A
A-285 WITH FAN	Upto 240 A for 3 SSR	-	-	-	-	-	-	75 A x 3 = 225 A	80 A x 3 = 240 A

* As per UL 508 2 AWG (33.6 Sq. mm) wire can draw 115 Amp at 40°C.

TYPE OF HEATSINKS / CURRENT RATING / $R_{\theta SA}$ / SURFACE AREA / MECHANICAL DIMENSIONS / WEIGHT

HEAT SINK TYPE "C-56" + DIN RAIL
 35mm Plastic Din Rail to SSR 10kV Isolation
 M4 Screw

TYPE "C-56"
 Model 901-1 Nos.
 Current upto **16Amp @40°C** with Din Rail 42mm,
 Thermal Resistance $R_{\theta SA} = 4^{\circ}\text{C/W}$
 $R_{\theta SA} = 277.15 \text{ K/W}$
 $\Delta T = 75^{\circ}\text{C}$
 Surface Area:
 $353\text{mm}^2 \times 56\text{mm} = 19768\text{mm}^3$
 $43\text{mm(W)} \times 56\text{mm(L)} \times 13.5\text{mm(H)} + \text{SSR}$
Inbuilt Heat Sink IN 901 SSR MODEL Weight : @ 57gms
No Separate Heat Sink available

HEAT SINK TYPE "G-68" + DIN RAIL
 35mm Plastic Din Rail to SSR 10kV Isolation
 M3 Screw

TYPE "G-68"
 Model 901-1 Nos.
 Model 808-1 Nos.
 Current upto **26Amp @40°C** with Din Rail 22.5mm,
 Thermal Resistance $R_{\theta SA} = 2.5^{\circ}\text{C/W}$
 $R_{\theta SA} = 275.65 \text{ K/W}$
 $\Delta T = 75^{\circ}\text{C}$
 Surface Area:
 $491\text{mm}^2 \times 68\text{mm} = 33388 \text{ mm}^3$
 $44\text{mm(W)} \times 68\text{mm(L)} \times 32\text{mm(H)} + \text{SSR}$
Weight : @ 95gms

HEAT SINK TYPE "B-48" + DIN RAIL
 35mm Plastic Din Rail to SSR 10kV Isolation
 M4 Screw

TYPE "B-48"
 Model 803-Upto 2 Nos.
 Model 901-1 Nos.
 Current upto **36Amp @40°C** with Din Rail 42mm
 Thermal Resistance $R_{\theta SA} = 1.17^{\circ}\text{C/W}$
 $R_{\theta SA} = 274.32 \text{ K/W}$
 $\Delta T = 75^{\circ}\text{C}$
 Surface Area:
 $2630\text{mm}^2 \times 48\text{mm} = 126240 \text{ mm}^3$
 $48\text{mm(W)} \times 87\text{mm(L)} \times 80\text{mm(H)} + \text{SSR}$
Weight : @ 310gms

HEAT SINK TYPE "B-72" + DIN RAIL
 35mm Plastic Din Rail to SSR 10kV Isolation
 M4 Screw

TYPE "B-72"
 Model 803-Upto 3 Nos.
 Model 901-1 Nos.
 Current upto **60Amp @40°C** with Din Rail 42mm
 Thermal Resistance $R_{\theta SA} = 0.85^{\circ}\text{C/W}$
 $R_{\theta SA} = 274 \text{ K/W}$
 $\Delta T = 75^{\circ}\text{C}$
 Surface Area:
 $2630\text{mm}^2 \times 72\text{mm} = 189360 \text{ mm}^3$
 $72\text{mm(W)} \times 87\text{mm(L)} \times 80\text{mm(H)} + \text{SSR}$
Weight : @ 500gms

HEAT SINK TYPE "A-100" + DIN RAIL
 35mm Plastic Din Rail to SSR 10kV Isolation
 M4 Screw
 Joint Plate

TYPE "A-100"
 Model 901-Upto 2 Nos.
 Model 905-Upto 1 Nos.
 Current upto **80Amp @40°C** with Din Rail 42mm
 Thermal Resistance $R_{\theta SA} = 0.65^{\circ}\text{C/W}$
 $R_{\theta SA} = 273.83 \text{ K/W}$
 $\Delta T = 75^{\circ}\text{C}$
 Surface Area:
 $2630\text{mm}^2 \times 100\text{mm} = 263000 \text{ mm}^3$
 $100\text{mm(W)} \times 87\text{mm(L)} \times 80\text{mm(H)} + \text{SSR}$
Weight : @ 690gms

Note : Specifications are subject to change without prior notice.

Web: www.unisoncontrols.com Email : info@unisoncontrols.com

Tel: +91-79-29759845, Mob: +91-62-62-700-700



UNISON CONTROLS PVT. LTD.

SOLID STATE RELAY

TYPE OF HEATSINKS / CURRENT RATING / R_{θSA} / SURFACE AREA / MECHANICAL DIMENSIONS / WEIGHT

HEAT SINK TYPE "A-190" WITH OUT FAN

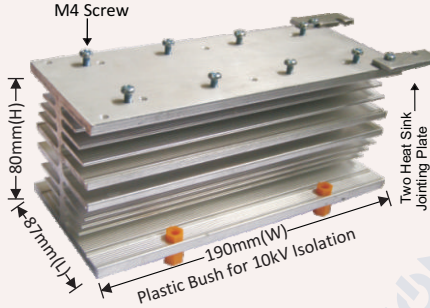

TYPE "A-190" WITH OUT FAN
 Model 901-Upto 4 Nos.
 Model 905-Upto 1 Nos.
 Model 803-Upto 4 Nos.
 Current upto 132Amp @40°C
 with Din Rail 42mm
 Thermal Resistance
 $R_{\theta SA} = 0.33^{\circ}\text{C/W}$
 $R_{\theta SA} = 273.48 \text{ K/W}$
 $\Delta T = 75^{\circ}\text{C}$
 Surface Area:
 $2630\text{mm}^2 \times 190\text{mm}$
 $= 499700 \text{ mm}^3$
 190mm(W) X 87mm(L)
 X 80mm(H) + SSR
 Weight : @ 1300gms

HEAT SINK TYPE "A-190" WITH 230VAC FAN

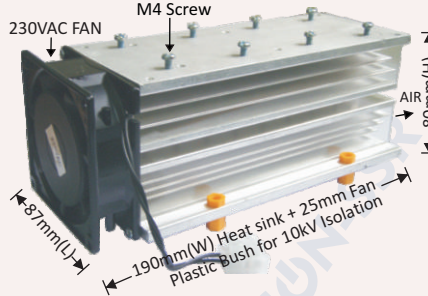

TYPE "A-190" WITH 230VAC FAN
 Model 901-Upto 4 Nos.
 Model 905-Upto 1 Nos.
 Model 803-Upto 4 Nos.
 Current upto 156Amp @40°C
 with Din Rail 42mm
 Thermal Resistance
 $R_{\theta SA} = 0.22^{\circ}\text{C/W}$
 $R_{\theta SA} = 273.37 \text{ K/W}$
 $\Delta T = 75^{\circ}\text{C}$
 Surface Area:
 $2630\text{mm}^2 \times 190\text{mm}$
 $= 499700 \text{ mm}^3$
 190mm(W) X 87mm(L)
 X 80mm(H) + SSR
 Weight : @ 1530gms

HEAT SINK TYPE "A-285" WITH OUT FAN

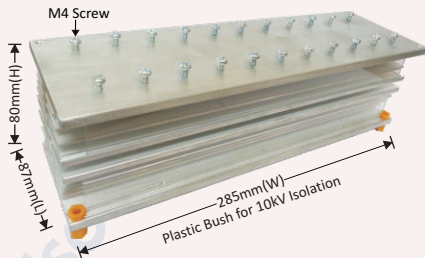

TYPE "A-285" WITH OUT FAN
 Model 901-Upto 6 Nos.
 Model 905-Upto 2 Nos.
 Model 803-Upto 11 Nos.
 Current upto 210Amp @40°C
 with Din Rail 42mm
 Thermal Resistance
 $R_{\theta SA} = 0.09^{\circ}\text{C/W}$
 $R_{\theta SA} = 273.24 \text{ K/W}$
 $\Delta T = 75^{\circ}\text{C}$
 Surface Area:
 $2630\text{mm}^2 \times 285\text{mm}$
 $= 749550 \text{ mm}^3$
 285mm(W) X 87mm(L)
 X 80mm(H) + SSR
 Weight : @ 1950gms

HEAT SINK TYPE "A-285" WITH 230VAC FAN

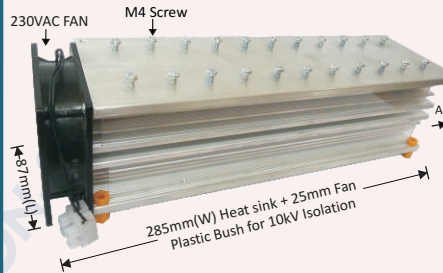

TYPE "A-285" WITH 230VAC FAN
 Model 901-Upto 6 Nos.
 Model 905-Upto 2 Nos.
 Model 803-Upto 11 Nos.
 Current upto 240Amp @40°C
 with Din Rail 42mm
 Thermal Resistance
 $R_{\theta SA} = 0.04^{\circ}\text{C/W}$
 $R_{\theta SA} = 273.19 \text{ K/W}$
 $\Delta T = 75^{\circ}\text{C}$
 Surface Area:
 $2630\text{mm}^2 \times 285\text{mm}$
 $= 749550 \text{ mm}^3$
 285mm(W) X 87mm(L)
 X 80mm(H) + SSR
 Weight : @ 2175gms

50AMP- MODEL 901 ZDA 60 50 01 AL5



Weight: 110gms SSR +
 95gms G-68 Heat sink

200AMP-MODEL 901 ZDA 60 200 01 CU2 - 1 Nos. SSR

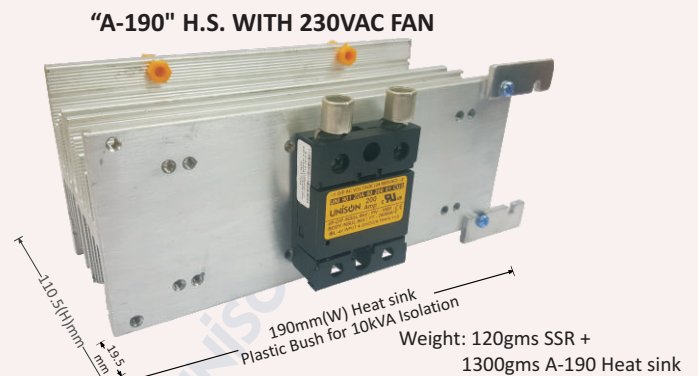

Weight: 120gms SSR +
 1300gms A-190 Heat sink

90AMP- MODEL 901 ZDA 60 90 01 CU2



Weight:
 120gms SSR +
 690gms A-100 Heat sink

200AMP-MODEL 901 ZDA 60 200 01 CU2- 3Nos. SSR



Weight: 120gms 3NOS. SSR +
 2175gms A-285 Heat sink

Note : Specifications are subject to change without prior notice.

Web: www.unisoncontrols.com Email : info@unisoncontrols.com

Tel: +91-79-29759845, Mob: +91-62-62-700-700



APPLICATIONS

UNISON CONTROLS PVT. LTD.-SOLID STATE RELAY

PLASTIC PROCESSING INDUSTRY



- Sheet Plant
- Rubber Moulding
- Compression Moulding
- Pet Bottle Moulding

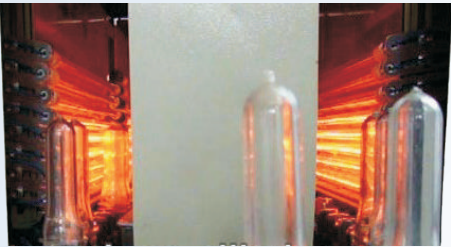

- Plastic Extrusion
- Injection Moulding
- Blow Moulding
- Plastic Dryers
- Hot Runner Systems

- Liquid form filled sealing
- Bagger bagging
- Carry bag making
- Shrink Tunnels
- Solid Shrink & Wrap Machinery
- Aseptic Packaging
- Wrapping Machines
- Liquid Pick fill and seal Machines

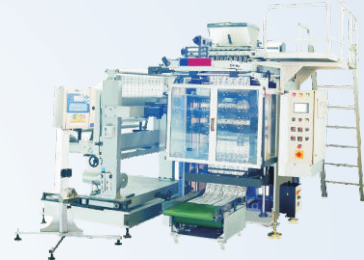

RUBBER MOULDING

PACKAGING INDUSTRY

TEXTILE AND PRINTING MACHINERY



- Blister Packing Machinery
- Infrared dryers / curing machine
- Heat Transfer Process
- Texturing Machine
- Hot Foil Stamping Machine
- Coating Machinery
- Laminating Machinery
- Heat screen printing

- Tube Filling Machine
- Air conditioner / Air dryer
- Food Service equipment
- Ambient heating & ventilation
- Dispensing Machinery (Fuel)
- Pizza Ovens
- Lighting control in Hotel & traffic signals
- Electrical grills and Ovens
- Vending machine



- Industrial Furnace & Ovens
- Stencil Printer
- Electronic reflow oven
- Scientific equipment
- Laboratory equipment
- Testing equipment
- Medical equipment
- Wire annealing
- Assay / Hole Marking
- Electrical Boiler
- Monogram Making
- Duct heater of AHU Panel

AUTOMOBILE, ELECTRONICS & INDUSTRIAL HEATING

FOOD - BEVERAGE & HOTEL APPLICATION

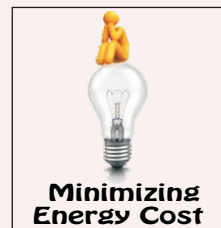
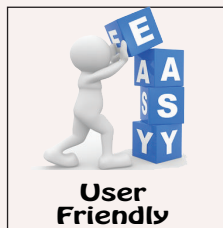

Note : Specifications are subject to change without prior notice.

Web: www.unisoncontrols.com Email : info@unisoncontrols.com

Tel: +91-79-29759845, Mob: +91-62-62-700-700

